

DRI2530TEN

 MERIT SERIES GAS INSERTS















**Superior**  
FIREPLACES  
*Our name is our promise.*



**TRADITIONAL**

The DRI2530TEN Direct Vent Gas Insert offers the convenience and efficiency of gas, the look of a real wood fire and a variety of options to enhance any décor.

**FEATURES**

-  Available in a 32" circulating radiant model
-  Approved for use with zero clearance and masonry fireplaces
-  Gas controls are conveniently hidden at the bottom of the fireplace opening for easy installation and finishing
-  Electronic ignition with IPI/CPI switch and battery backup to provide continued operation in the event of a power outage
-  Pan burner with up to 33,000 BTU's
-  65.6% AFUE/P4 heating efficiency
-  Detailed ceramic fiber logs with integrated log grate
-  Features ceramic glass for optimum heat transfer
-  Factory installed heat activated variable speed blower
-  Black painted interior
-  Optional remote control (T'stat only)
-  20 year limited warranty

**INTERIOR LINER OPTIONS (Required)**



Tan Brick

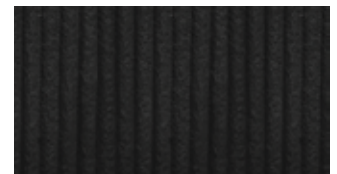

Zen Garden



Red Brick



Architectural Stone

## INSERT CLEARANCES

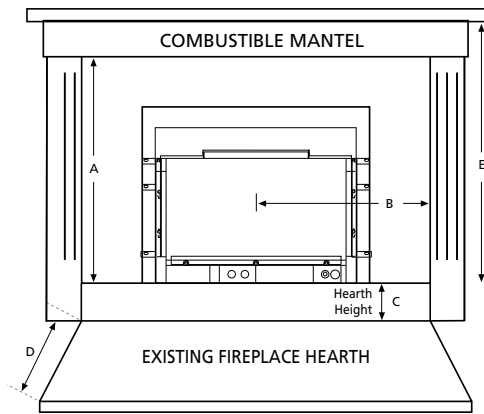

### DRI2530TEN

A	31-1/2"
B	25-1/2"
C	0" 2" 4" DISTANCE TO FLOOR
D	13" 10" 0" HEARTH DEPTH
E	39"

Hearth protection to be a minimum of 3/8" thick non-combustible or equivalent, w/ a k factor of .84

## INSERT DIMENSIONS

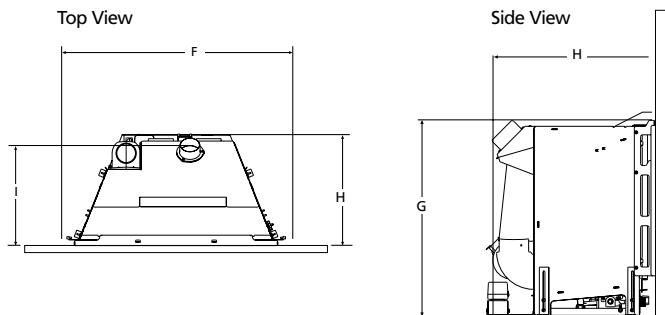

### DRI2530TEN

F	Front Width	31-1/4"
G	Overall Unit Height to Top of 3" Flue Collar	19-3/8"
H	Unit Depth	15-7/8"
I	Depth to Centerline of 3" Flue Collar	13-3/8"

## OPTIONAL ACCESSORIES

### Facades (One required)



Black Facade



Mink Facade



Remote Control

## ADDITIONAL ACCESSORIES

- A. Decorative Screen
- B. LP Gas Conversion Kits
- C. Surround Panel Kits
- D. Surround Trim Kits
- E. Zero Clearance Support Kit

## MINIMUM FIREPLACE OPENING

### DRI2530TEN

FRONT WIDTH	31-1/2"
REAR WIDTH	18"
HEIGHT	19-1/2"
DEPTH	16"

## INSERT SPECIFICATIONS

Heating Capacity*	900-2,000 sq. ft.	
Insert Weight	144 lbs.	
BTU Input	NG	24,000-33,000
	LP	24,000-33,000
AFUE/P4	NG	65.55%
Energide	LP	67.80%
Blower	155-CFM Variable-Speed Blower (standard)	
Vent Pipe	Colinear 3" Flex Vent	

\*Square-foot heating capacities are approximations only. Actual performance may vary depending upon home design and insulation, ceiling heights, climate, appliance location, accessories chosen, chimney installation and how the appliance is operated.



© 2014 Innovative Hearth Products

785517M 07/14

Visit us online



SuperiorFireplaces.us.com

